

CoreLine Projector

ST120T LED24S-24-/840 PSU BK



ST120T - LED Module, system flux 2400 lm - Power supply unit

The CoreLine Projector range of luminaires is designed to replace halogen and CDM-standard-based projectors. Their clean lines and attractive TCO help customers to make the switch to LED. These luminaires create a natural lighting effect for use in accent lighting applications. They also deliver instant energy savings and have a much longer lifetime, creating a real value-for-money and environmentally friendly solution. They are easy to install on a standard track or by means of a surface-mount connector.



PHILIPS

Product data

• General information

Product family code	ST120T [ST120T]
Number of light sources	1 [1 pc]
Lamp family code	LED24S [LED Module, system flux 2400 lm]
Beam angle of light source	24 D [24°]
Light source color	840 [840 neutral white]
Driver/power unit/transformer	PSU [Power supply unit]
Driver included	true [Yes]
Dimmable	No [No]
Ingress protection code	IP20 [Finger-protected]
Mech. impact protection code	IK02 [0.2 J standard]
Color	BK [Black]
Glow-wire test	650/5 [Temperature 650 °C, duration 5 s]
CE mark	CE [CE mark]

• Electrical

Input voltage	220-240 V [220 to 240 V]
Input frequency	50-60 Hz [50 to 60 Hz]

• Mechanical

Housing material	ALU [Aluminum]
Reflector material	PC [Polycarbonate]
Optic material	PC [Polycarbonate]

• Initial perform. (IEC compliant)

Initial input power	33 W [33 W]
---------------------	-------------

Initial luminous flux	2400 Lm
Init. Corr. Color Temperature	4000 [4000 K]
Init. Color Rendering Index	80 [80]

• Application conditions

Average ambient temperature	T25 [+25 °C]
Ambient temperature range	0 to +35°C [0 to +35 °C]

• Product Data

Order code	910503910093
Full product code	910503910093
Full product name	ST120T LED24S-24-/840 PSU BK
Order product name	ST120T LED24S-24-/840 PSU BK
Pieces per pack	1
Packs per outerbox	12
Bar code on pack - EAN1	8718696069479
Bar code on outerbox - EAN3	8718696069554
Logistic code(s) - 12NC	910503910093
Net weight per piece	0.361 kg



Dimensional drawing

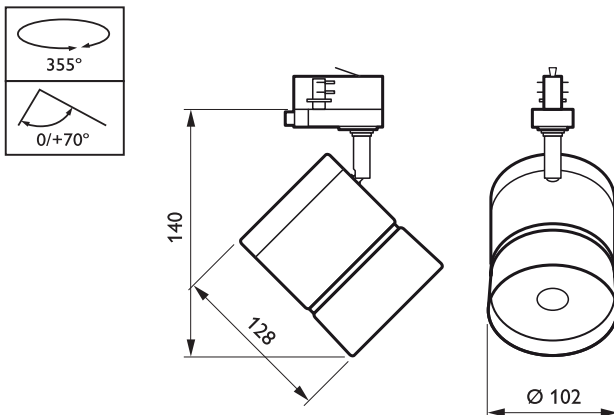

ST120T LED24S-24-/840 PSU BK



© 2015 Koninklijke Philips N.V. (Royal Philips)
All rights reserved.

Specifications are subject to change without notice. Trademarks are the property of Koninklijke Philips N.V. (Royal Philips) or their respective owners.

www.philips.com/lighting

2015, October 7
data subject to change