



MASTER LEDspot LV

MASTER LEDspotLV VLE D 6.3-35W 827 MR16 36D

Delivering a warm, halogen-like accent beam, MASTER LEDspot LV is an ideal retrofit solution for spot and general lighting applications in the hospitality industry. It is particularly suited to public areas such as receptions, lobbies, corridors, stairwells and washrooms, where the light is on all the time. The robustly designed MASTER LEDspot offers a choice of beam angles for a clearly defined beam spread. There is no UV or IR in the beam, making it suitable for illuminating heat-sensitive objects (food, organic materials, paintings, etc.). The patented intelligent driver enables broad compatibility with existing electromagnetic and electronic halogen transformers. The dimmable versions drive further efficiencies, while helping to create the desired atmosphere.

Product data

• General Characteristics

Cap-Base	GU5.3
Bulb	MR16 [MR 16inch/50mm]
Rated Lifetime (hours)	25000 hr
Nominal Lifetime hours	25000 hr

• Light Technical Characteristics

Color Code	827
Color Designation (text)	Warm White
Beam Angle	36 D
Beam Description	36D [Medium beam]
Correlated Color Temperature	2700 K
Luminous Flux	380 Lm
Luminous Intensity	980 cd
Color rendering index	80
Luminous Efficacy Lamp	60.00 Lm/W
Color Temperature	2700 K [CCT 2700K]
Rated Luminous Flux	380 Lm
LLMF - end nominal lifetime	70 %
Colour consistency	6 steps
Rated Beam Angle	36 D
Luminous flux in 90° cone	380 Lm

• Electrical Characteristics

Wattage	6.3 W
Wattage Technical	6.3 W
Voltage	12 V

Power Factor	0.7 -
Lamp Current mA	800 mA
Dimmable	Yes
Wattage Equivalent	35 W
Rated Wattage	6.3 W
Starting Time	0.5 (max) s
Warm-up Time to 60% Light Outp	instant full light
Suitable for accent lighting	Yes

• Temperature Characteristics

T-case maximum	100 (max) C
----------------	-------------

• Environmental characteristics

Energy Efficiency Label (EEL)	A
Energy consumption kWh/1000h	7 kWh

• Measuring Conditions

Switching cycle	50000X
-----------------	--------

• Product Dimensions

Overall Length C	50.5 mm
Diameter D	50.5 mm

• Product Data

Order code	929001151702
Full product code	929001151702
Full product name	MASTER LEDspotLV VLE D 6.3-35W 827 MR16 36D



PHILIPS

MASTER LEDspot LV

Order product name MAS LEDspotLV VLE D 6.3-35W 827 MR16 36D
Pieces per pack 1
Packing configuration 10
Packs per outerbox 10
Bar code on pack - EAN1 8718696490273

Bar code on outerbox - EAN3 8718696490280
Logistic code(s) - 12NC 929001151702
Net weight per piece 0.045 kg

Warnings and Safety

- Operating temperature range is between -20° C and 45° C ambient

- Only to apply in dry or damp locations and most of open fixtures with lamp-holders that offer sufficient space (10 mm free air space)
- Not intended for use with emergency light fixtures or exit lights

Dimensional drawing

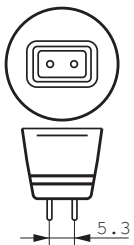
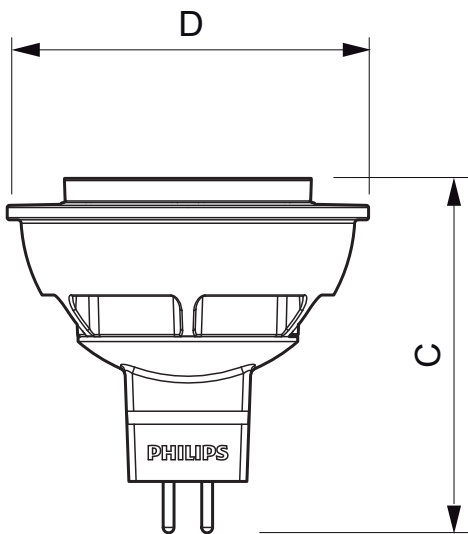

GU5.3

MASTER LEDspotLV VLE D 6.3-35W 827 MR16 36D

Product	C (Norm)	D (Norm)
LED VLE D 6.3-35W 827 MR16 36D	50.5	50.5

Photometric data

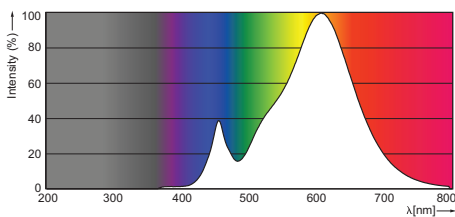

VLE D 6.3-35 W GU5.3 /827 MR16



© 2015 Koninklijke Philips N.V. (Royal Philips)
All rights reserved.

Specifications are subject to change without notice. Trademarks are the property of Koninklijke Philips N.V. (Royal Philips) or their respective owners.

www.philips.com/lighting

2015, August 29
data subject to change