



MASTER LEDspot LV AR111

MASTER LEDspotLV AR111 D 11-50W 930 40D

Delivering a warm, halogen-like accent beam, MASTER LEDspot LV AR111 is an ideal retrofit solution for spot and general lighting applications in the hospitality and retail industry. It is particularly suitable for general lighting where the light is on all the time, such as creative accent lighting applications in shops, restaurants, hotels, and especially for galleries, exhibitions and museums. The robustly designed MASTER LEDspot LV AR111 offers various beam angles for a clearly defined beam spread. There is no UV or IR in the beam, making it suitable for illuminating heat-sensitive objects (food, organic materials, paintings, etc.). The patented intelligent driver enables broad compatibility with existing electromagnetic and electronic halogen transformers. MASTER LEDspot LV AR111 delivers huge energy savings and minimizes maintenance cost without any reduction in brightness.

Product data

• General Characteristics

Cap-Base	GX53
Bulb	AR111
Rated Lifetime (hours)	40000 hr
Nominal Lifetime hours	40000 hr

• Light Technical Characteristics

Color Code	930
Color Designation (text)	White
Beam Angle	40 D
Beam Description	40D [Medium beam]
Correlated Color Temperature	3000 K
Luminous Flux	640 Lm
Luminous Intensity	1150 cd
Color rendering index	90
Luminous Efficacy Lamp	58.18 Lm/W
Color Temperature	3000 K [CCT 3000K]
Rated Luminous Flux	640 Lm
LLMF - end nominal lifetime	70 %
Colour consistency	6 steps
Rated Beam Angle	40 D
Luminous flux in 90° cone	570 Lm

• Electrical Characteristics

Wattage	11 W
Wattage Technical	11 W
Voltage	12 V

Power Factor	0.7 -
Lamp Current mA	1300 mA
Dimmable	Yes
Wattage Equivalent	50 W
Rated Wattage	11 W
Starting Time	0.5 (max) s
Warm-up Time to 60% Light Outp	instant full light
Suitable for accent lighting	Yes

• Temperature Characteristics

T-case maximum	70 C
----------------	------

• Environmental characteristics

Energy Efficiency Label (EEL)	A
Energy consumption kWh/1000h	13 kWh

• Measuring Conditions

Switching cycle	50000X
-----------------	--------

• Product Dimensions

Overall Length C	62.27 mm
Diameter D	111 mm

• Product Data

Order code	929001170102
Full product code	929001170102
Full product name	MASTER LEDspotLV AR111 D 11-50W 930 40D



PHILIPS

MASTER LEDspot LV AR111

Order product name MAS LEDspotLV AR111 D 11-50W
930 40D
Pieces per pack 1
Packing configuration 6
Packs per outerbox 6
Bar code on pack - EAN1 8718696514948

Bar code on outerbox - EAN3 8718696514955
Logistic code(s) - 12NC 929001170102
Net weight per piece 0.360 kg

Dimensional drawing

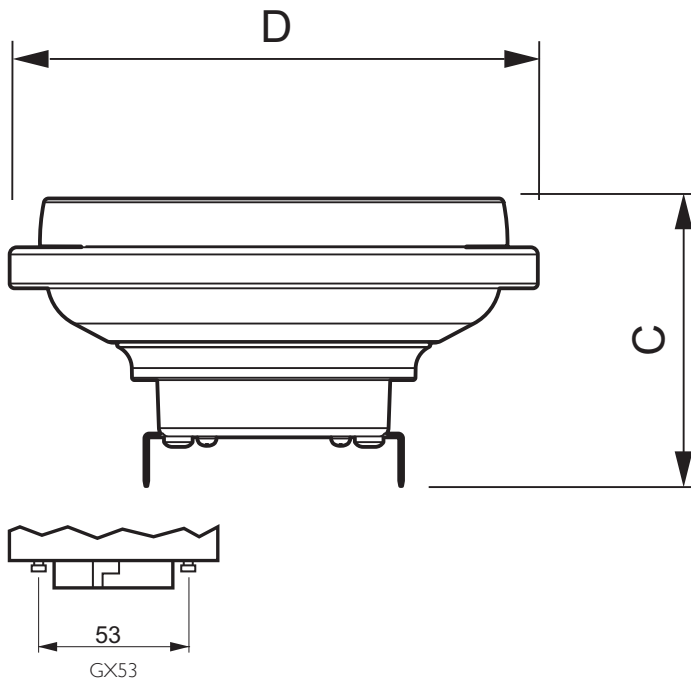

MASTER LEDspotLV AR111 D 11-50W 930 40D

Product	C (Norm)	D (Norm)
LED D 11-50W 930 AR111 40D	62.27	111

Photometric data

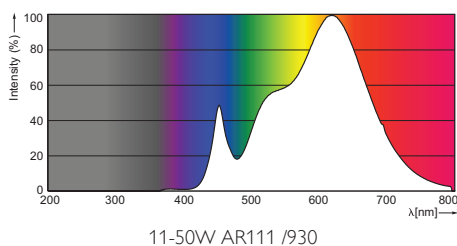

© 2015 Koninklijke Philips N.V. (Royal Philips)
All rights reserved.

Specifications are subject to change without notice. Trademarks are the property of Koninklijke Philips N.V. (Royal Philips) or their respective owners.

www.philips.com/lighting

2015, August 29
data subject to change